

CHZ25

單軸
1-axis

滑動螺桿

ACME Lead Screw Drive

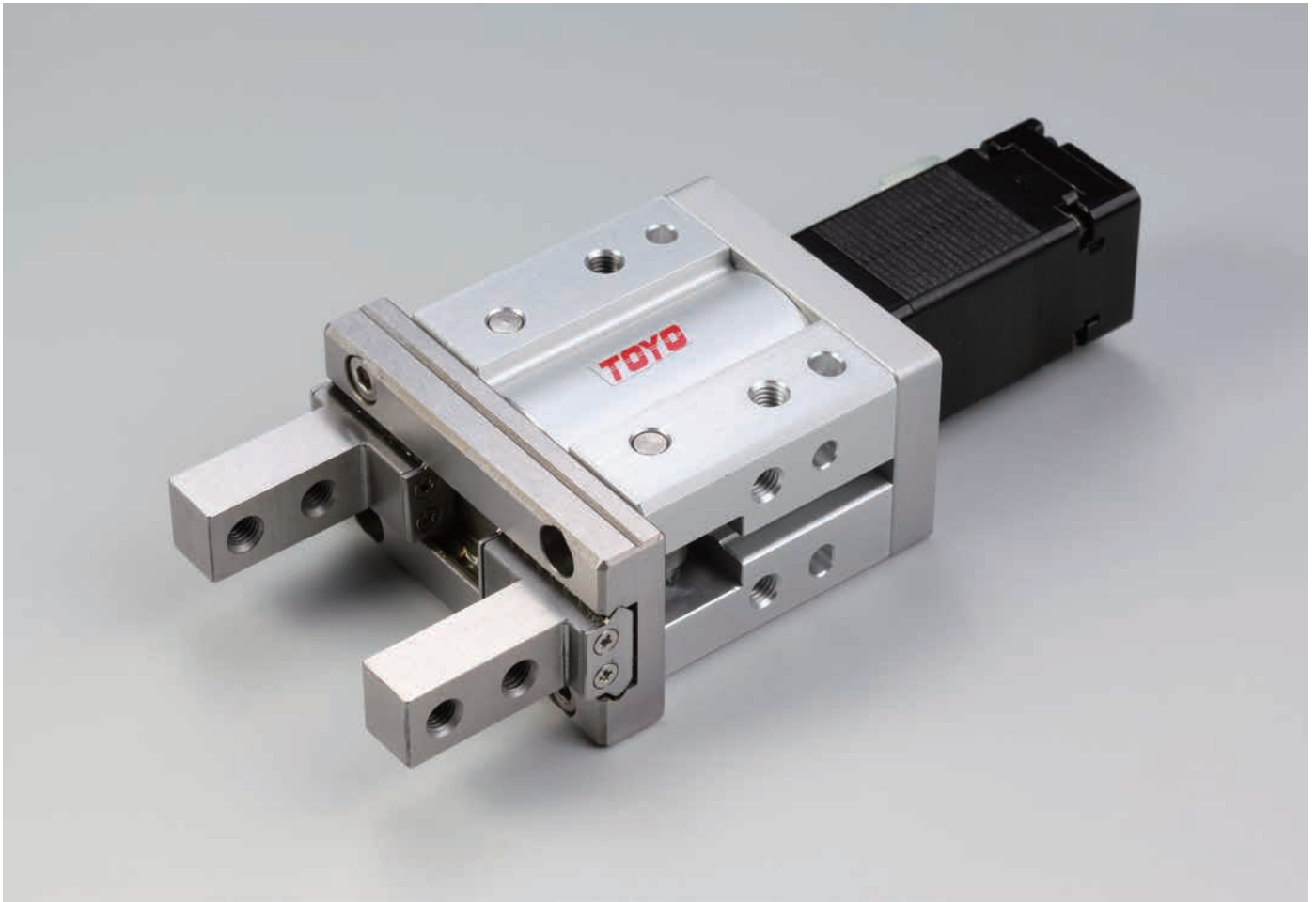

馬達尺寸
Motor Dimension 25□mm

型號表示方式 Ordering Method

CHZ25 - S14 - TC100 - 03 - A0001

本體型號
Model

特注式樣
Customization Order No.

螺桿導程
ACME Lead Screw

S14	標準型 Standard Type
N14	窄型 Narrow Type

對應控制器
Corresponding Controller

TC100

線長
Cable Length

01	1m
03	3m
05	5m
10	10m

標配3m
Standard:3m

基本仕様 Specification

規格 Spec	夾持力範圍 Gripping force (N)	22~98
	開閉行程 Open and close stroke *1 (mm)	14
	開閉速度 Open and close speed (mm/s)	5~50
	位置重複精度 Position repeatability (mm)	±0.02
	導引機構 Guide structure	線性滑軌 Linear guide
	使用溫度範圍 Operating temperature range (°C)	0~+40
	使用濕度範圍 Operating humidity range (%)	RH90以下 Below RH90
部品 Parts	馬達尺寸 Motor Dimension (mm)	25□
	重量 Weight (g) *2	552

*1 雙邊合計行程。Total stroke of both sides.
*2 重量包含本體與馬達。Weight of model with motor.

夾持力與指令值曲線表 Gripping Power vs. Gripping Power Setting (%)

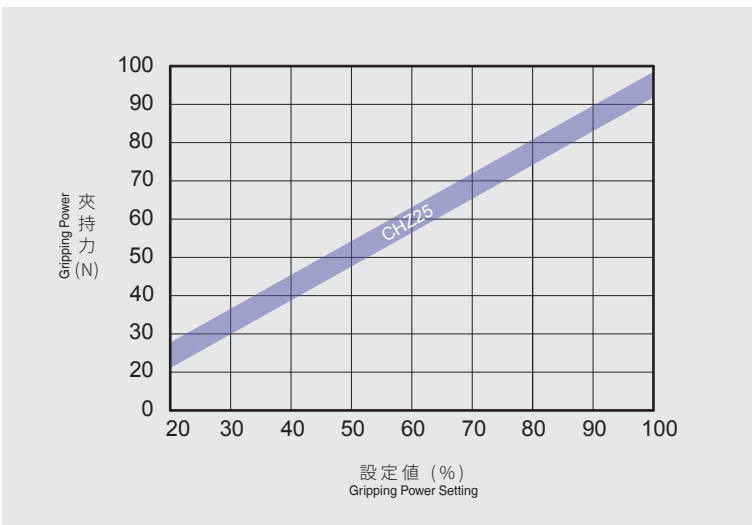

容許夾持負載力矩表 Allowable Moment

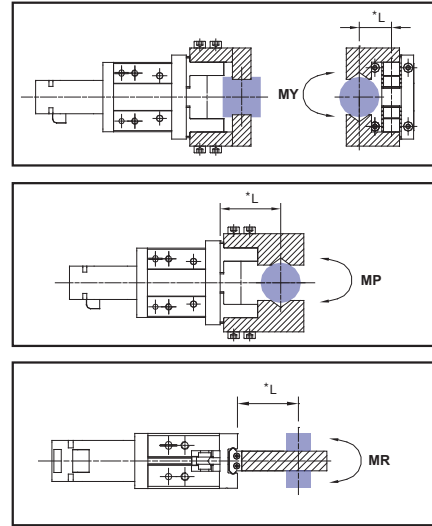

*L: 夾爪至負荷作用點之距離(mm)
Distance to the loading location (單位 Unit:N.m)

最大容許力矩 Maximum moment		
偏力矩 Allowable yawing moment	MY	1.94
俯仰力矩 Allowable pitching moment	MP	1.94
滾動力矩 Allowable rolling moment	MR	3.88

*表中負荷及力矩的值表示靜的値
The value in the chart is static, not dynamic loading and torque.

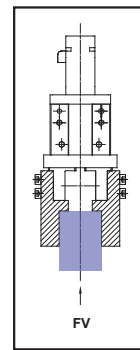

(單位 Unit:N)

垂直方向容許靜負荷 FV Vertical Maximum Force	255
--	-----

對應控制器一覽表 Corresponding Controller Chart

外觀 Exterior	控制器型號 Controller Model	控制介面 Control Mode	特點 Features	電氣規格 Electrical Spec.	詳細參閱 Reference Page
	TC100	Pulse控制 Pulse Control Mode	Line driver 500k Hz Open collector 200k Hz 同時間只能使用一種。 Support Line driver and Open collector Max.pulse receiving speed 500k/200k Hz.	控制電路只能使用24V。 工作電壓DC24V， 額定電流 2A，峰值電流3A。 工作電壓DC48V， 額定電流 1A，峰值電流2A。	P.99
		I/O控制 I/O Control Mode	利用I/O變化，最多可以執行127個位置控制。 By I/O control, max. 127 positioning points, can be executed.	使用DC48V時在相同扭力下，轉速會提升，詳細內容請跟服務窗口連絡。 The voltage of control circuit is 24V only.	
		通訊控制 Communication Control Mode	採Modbus的RS485通訊介面(最大並接16台)及一組mini USB (TOYO Single專用)。 Use Modbus as the interface of RS485 (connect max. 16 controllers) and 1 set mini USB. (special for TOYO-single)	Operating voltage DC24V, rated current 2A, peak current 3A. Operating voltage DC48V, rated current 1A, peak current 2A. When the voltage is DC48V but same torque, the rotation speed will be raised. Please contact your service window to details.	

CHZ25

單軸
1-axis

螺桿驅動

ACME Lead Screw Drive

S14 標準型 Standard Type



• CAD圖面可至www.toyorobot.com下載
Please download the CAD file from TOYO's website: www.toyorobot.com

(單位 Unit : mm)

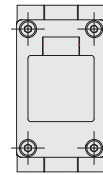
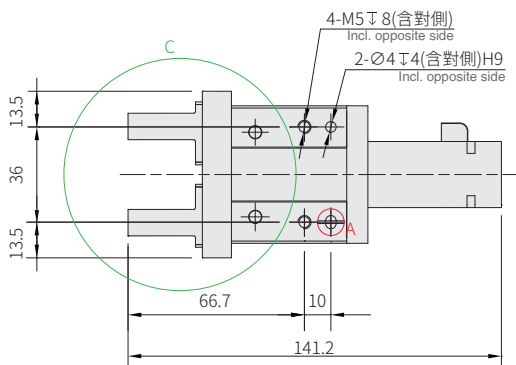
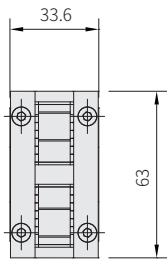
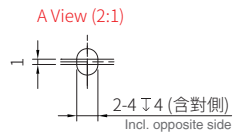
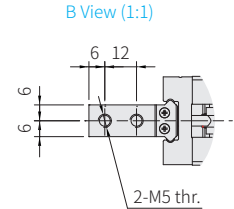
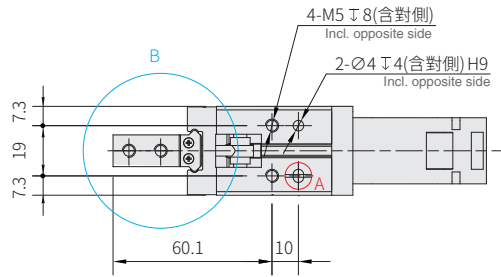
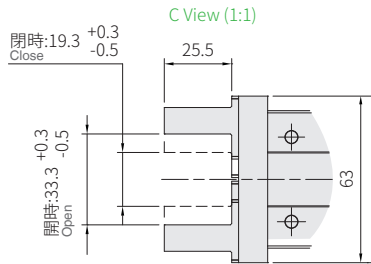

N14 窄型 Narrow Type



• CAD圖面可至www.toyorobot.com下載
Please download the CAD file from TOYO's website: www.toyorobot.com

(單位 Unit : mm)

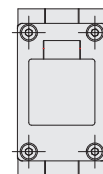
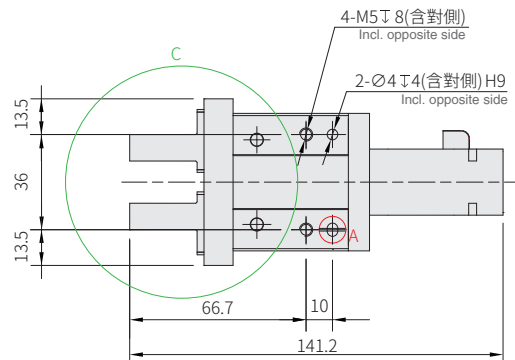
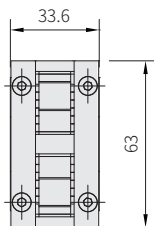
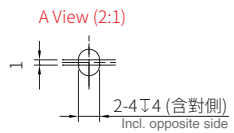
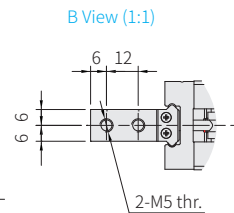
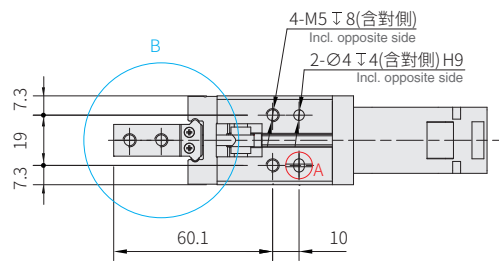
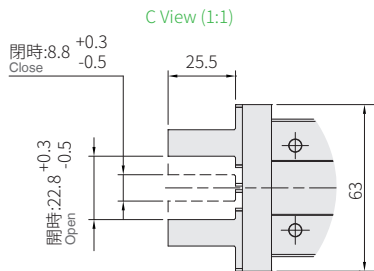

免費服務專線：大陸 **400-875-0009** 台灣 **0800-800-893**
Toll-Free Number China Taiwan

Memo

CTH 系列
Slider Cylinder

CY 系列
Rod Cylinder

CS 系列
Electric miniature cylinder

CH 系列
Electric gripper

控制器規格
Spec. of controller

CH
CHZ20
CHZ25