

LMR32 單軸 1-axis

軸棒線馬 Linear shaft motor

LMR32-08-RH-N



• CAD圖面可至www.toyorobot.com下載 •
Please download the CAD file from TOYO's website: www.toyorobot.com

單位 Unit : mm

履帶截面圖
Sectional view of connecting track

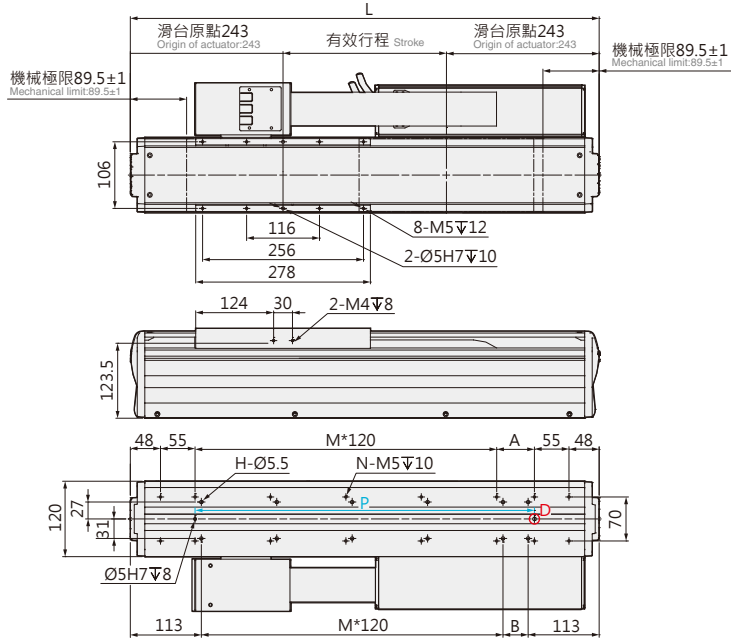
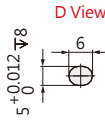
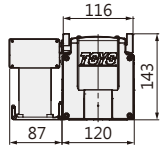
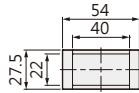

有效行程 stroke	140	200	260	320	380	440	500	560	620	680	740	800	860	920	980	1040	1100	1160	1220	1280	1340	1400	1460	1520	1580	1640	1700	1760	1820	1880
L	626	686	746	806	866	926	986	1046	1106	1166	1226	1286	1346	1406	1466	1526	1586	1646	1706	1766	1826	1886	1946	2006	2066	2126	2186	2246	2306	2366
A	60	120	60	120	60	120	60	120	60	120	60	120	60	120	60	120	60	120	60	120	60	120	60	120	60	120	60	120	60	120
B	40	100	40	100	40	100	40	100	40	100	40	100	40	100	40	100	40	100	40	100	40	100	40	100	40	100	40	100	40	100
P	420	480	540	600	660	720	780	840	900	960	1020	1080	1140	1200	1260	1320	1380	1440	1500	1560	1620	1680	1740	1800	1860	1920	1980	2040	2100	2160
M	3	3	4	4	5	5	6	6	7	7	8	8	9	9	10	10	11	11	12	12	13	13	14	14	15	15	16	16	17	17
N	14	14	16	16	18	18	20	20	22	22	24	24	26	26	28	28	30	30	32	32	34	34	36	36	38	38	40	40	42	42
H	10	10	12	12	14	14	16	16	18	18	20	20	22	22	24	24	26	26	28	28	30	30	32	32	34	34	36	36	38	38
KG	17.3	18.5	19.7	20.9	22.2	23.4	24.6	25.9	27.1	28.3	29.6	30.8	32	33.2	34.5	35.7	36.9	38.2	39.4	40.6	41.9	43.1	44.3	45.5	46.8	48	49.2	50.5	51.7	52.9

LMR32-08-RH-D



• CAD圖面可至www.toyorobot.com下載 •
Please download the CAD file from TOYO's website: www.toyorobot.com

單位 Unit : mm

履帶截面圖
Sectional view of connecting track

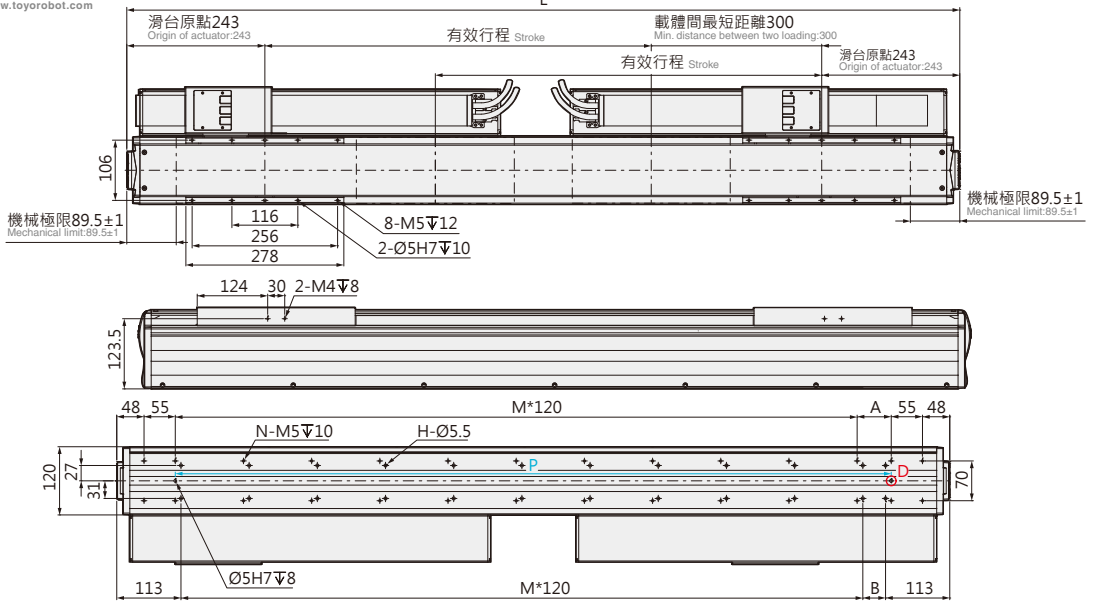
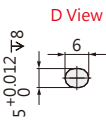
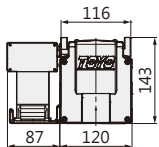
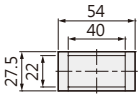

有效行程 stroke	80	140	200	260	320	380	440	500	560	620	680	740	800	860	920	980	1040	1100	1160	1220	1280	1340	1400	1460	1520	1580
L	866	926	986	1046	1106	1166	1226	1286	1346	1406	1466	1526	1586	1646	1706	1766	1826	1886	1946	2006	2066	2126	2186	2246	2306	2366
A	60	120	60	120	60	120	60	120	60	120	60	120	60	120	60	120	60	120	60	120	60	120	60	120	60	120
B	40	100	40	100	40	100	40	100	40	100	40	100	40	100	40	100	40	100	40	100	40	100	40	100	40	100
P	660	720	780	840	900	960	1020	1080	1140	1200	1260	1320	1380	1440	1500	1560	1620	1680	1740	1800	1860	1920	1980	2040	2100	2160
M	5	5	6	6	7	7	8	8	9	9	10	10	11	11	12	12	13	13	14	14	15	15	16	16	17	17
N	18	18	20	20	22	22	24	24	26	26	28	28	30	30	32	32	34	34	36	36	38	38	40	40	42	42
H	14	14	16	16	18	18	20	20	22	22	24	24	26	26	28	28	30	30	32	32	34	34	36	36	38	38
KG	28.9	30.1	31.3	32.6	33.8	35	36.3	37.5	38.7	40	41.2	42.4	43.6	44.9	46.1	47.3	48.6	49.8	51	52.2	53.5	54.7	55.9	57.2	58.4	59.6

免費服務專線：大陸 400-875-0009 台灣 0800-800-893
Toll-Free Number China Taiwan

LMR32-08-LW-N



CAD圖面可至www.toyorobot.com下載
Please download the CAD file from TOYO's website: www.toyorobot.com

履帶截面圖
Sectional view of connecting track

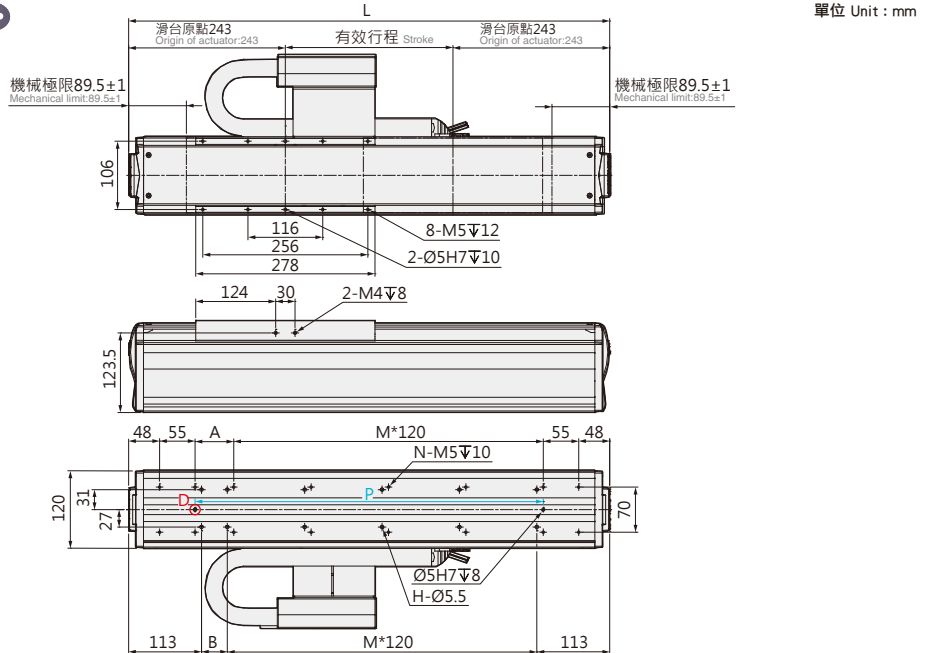
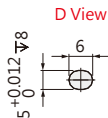
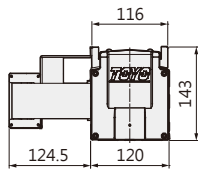
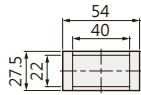

有效行程 stroke	140	200	260	320	380	440	500	560	620	680	740	800	860	920	980	1040	1100	1160	1220	1280	1340	1400	1460	1520	1580	1640	1700	1760	1820	1880
L	626	686	746	806	866	926	986	1046	1106	1166	1226	1286	1346	1406	1466	1526	1586	1646	1706	1766	1826	1886	1946	2006	2066	2126	2186	2246	2306	2366
A	60	120	60	120	60	120	60	120	60	120	60	120	60	120	60	120	60	120	60	120	60	120	60	120	60	120	60	120	60	120
B	40	100	40	100	40	100	40	100	40	100	40	100	40	100	40	100	40	100	40	100	40	100	40	100	40	100	40	100	40	100
P	420	480	540	600	660	720	780	840	900	960	1020	1080	1140	1200	1260	1320	1380	1440	1500	1560	1620	1680	1740	1800	1860	1920	1980	2040	2100	2160
M	3	3	4	4	5	5	6	6	7	7	8	8	9	9	10	10	11	11	12	12	13	13	14	14	15	15	16	16	17	17
N	14	14	16	16	18	18	20	20	22	22	24	24	26	26	28	28	30	30	32	32	34	34	36	36	38	38	40	40	42	42
H	10	10	12	12	14	14	16	16	18	18	20	20	22	22	24	24	26	26	28	28	30	30	32	32	34	34	36	36	38	38
KG	17.4	18.6	19.7	20.9	22	23.2	24.3	25.5	26.6	27.8	28.9	30	31.2	32.4	33.5	34.7	35.8	37	38.1	39.3	40.4	41.6	42.7	43.9	45	46.2	47.3	48.5	49.6	50.8

LMR32-08-LW-D



CAD圖面可至www.toyorobot.com下載
Please download the CAD file from TOYO's website: www.toyorobot.com

履帶截面圖
Sectional view of connecting track

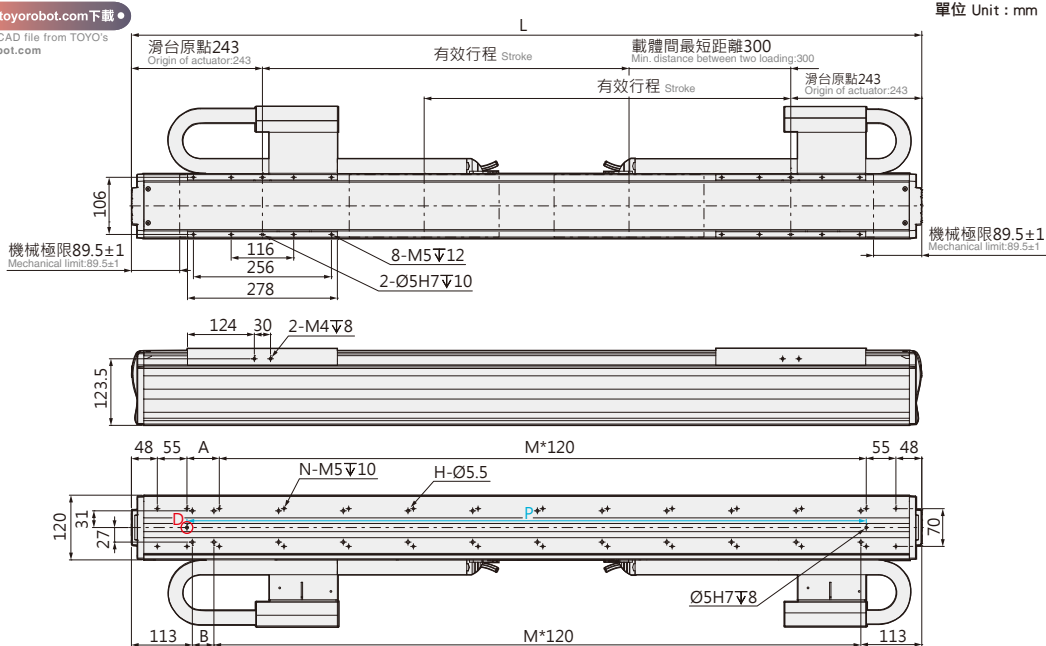
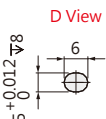
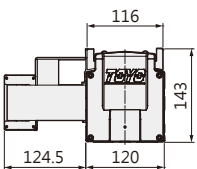
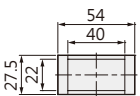

有效行程 stroke	80	140	200	260	320	380	440	500	560	620	680	740	800	860	920	980	1040	1100	1160	1220	1280	1340	1400	1460	1520	1580
L	866	926	986	1046	1106	1166	1226	1286	1346	1406	1466	1526	1586	1646	1706	1766	1826	1886	1946	2006	2066	2126	2186	2246	2306	2366
A	60	120	60	120	60	120	60	120	60	120	60	120	60	120	60	120	60	120	60	120	60	120	60	120	60	120
B	40	100	40	100	40	100	40	100	40	100	40	100	40	100	40	100	40	100	40	100	40	100	40	100	40	100
P	660	720	780	840	900	960	1020	1080	1140	1200	1260	1320	1380	1440	1500	1560	1620	1680	1740	1800	1860	1920	1980	2040	2100	2160
M	5	5	6	6	7	7	8	8	9	9	10	10	11	11	12	12	13	13	14	14	15	15	16	16	17	17
N	18	18	20	20	22	22	24	24	26	26	28	28	30	30	32	32	34	34	36	36	38	38	40	40	42	42
H	14	14	16	16	18	18	20	20	22	22	24	24	26	26	28	28	30	30	32	32	34	34	36	36	38	38
KG	28.6	29.8	30.9	32.1	33.2	34.3	35.5	36.6	37.8	38.9	40	41.2	42.3	43.5	44.6	45.7	46.9	48	49.2	50.3	51.4	52.6	53.7	54.9	56	57.1