

LMR25

單軸
1-axis

軸棒線馬

Linear shaft motor

LMR25-06-RH-N



CAD圖面可至www.toyorobot.com下載
Please download the CAD file from TOYO's website: www.toyorobot.com

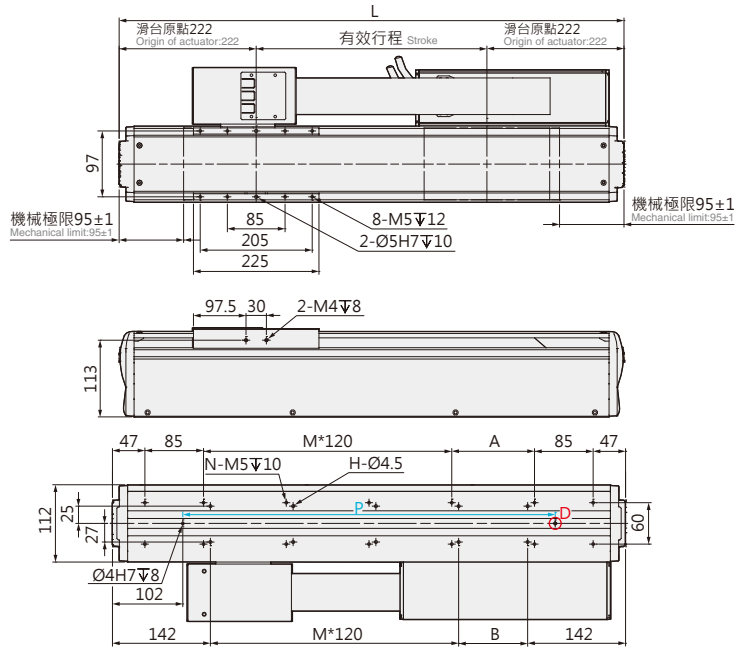
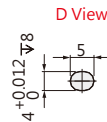
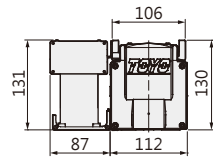
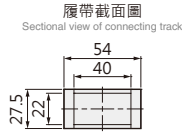

單位 Unit : mm

有效行程 stroke	120	180	240	300	360	420	480	540	600	660	720	780	840	900	960	1020	1080	1140	1200	1260
L	564	624	684	744	804	864	924	984	1044	1104	1164	1224	1284	1344	1404	1464	1524	1584	1644	1704
A	60	120	60	120	60	120	60	120	60	120	60	120	60	120	60	120	60	120	60	120
B	40	100	40	100	40	100	40	100	40	100	40	100	40	100	40	100	40	100	40	100
P	360	420	480	540	600	660	720	780	840	900	960	1020	1080	1140	1200	1260	1320	1380	1440	1500
M	2	2	3	3	4	4	5	5	6	6	7	7	8	8	9	9	10	10	11	11
N	12	12	14	14	16	16	18	18	20	20	22	22	24	24	26	26	28	28	30	30
H	8	8	10	10	12	12	14	14	16	16	18	18	20	20	22	22	24	24	26	26
KG	13.6	14.5	15.5	16.5	17.4	18.4	19.3	20.3	21.3	22.2	23.2	24.1	25.1	26.1	27	28	29	30	30.9	31.8

LMR25-06-RH-D



CAD圖面可至www.toyorobot.com下載
Please download the CAD file from TOYO's website: www.toyorobot.com

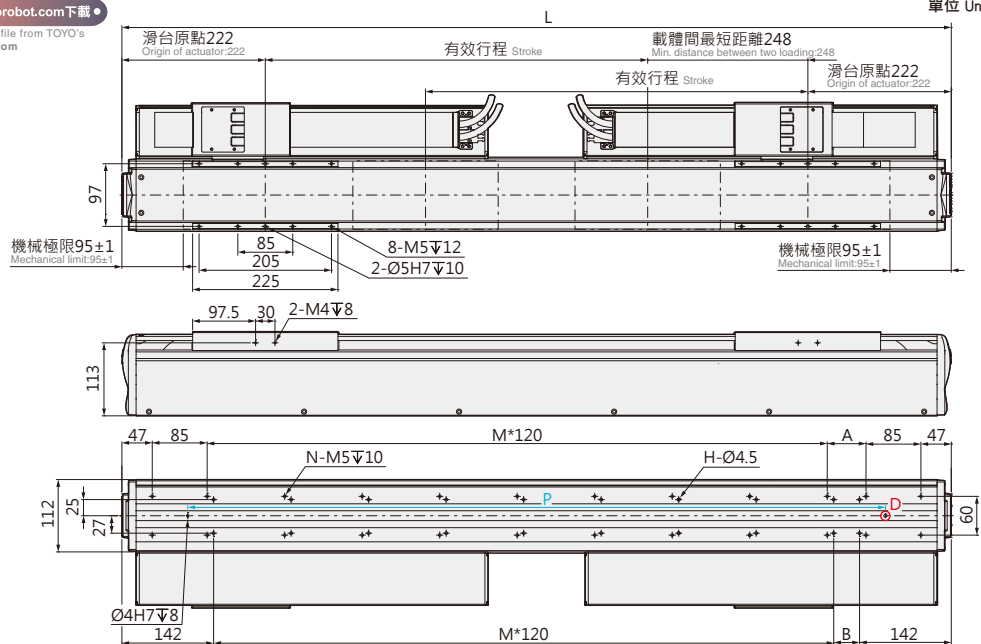
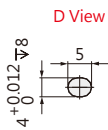
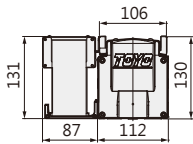
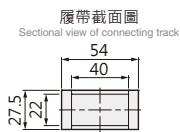

單位 Unit : mm

有效行程 stroke	50	110	170	230	290	350	410	470	530	590	650	710	770	830	890	950	1010
L	744	804	864	924	984	1044	1104	1164	1224	1284	1344	1404	1464	1524	1584	1644	1704
A	120	60	120	60	120	60	120	60	120	60	120	60	120	60	120	60	120
B	100	40	100	40	100	40	100	40	100	40	100	40	100	40	100	40	100
P	540	600	660	720	780	840	900	960	1020	1080	1140	1200	1260	1320	1380	1440	1500
M	3	4	4	5	5	6	6	7	7	8	8	9	9	10	10	11	11
N	14	16	16	18	18	20	20	22	22	24	24	26	26	28	28	30	30
H	10	12	12	14	14	16	16	18	18	20	20	22	22	24	24	26	26
KG	24.7	25.7	26.7	27.6	28.6	29.5	30.5	31.5	32.4	33.4	34.3	35.3	36.3	37.2	38.2	39.1	40.1

免費服務專線：大陸 400-875-0009 台灣 0800-800-893
Toll-Free Number China Taiwan

LMR25-06-LW-N



CAD圖面可至www.toyorobot.com下載
Please download the CAD file from TOYO's website: www.toyorobot.com

履帶截面圖
Sectional view of connecting track

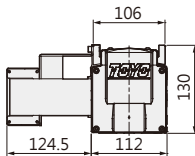
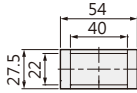

D View

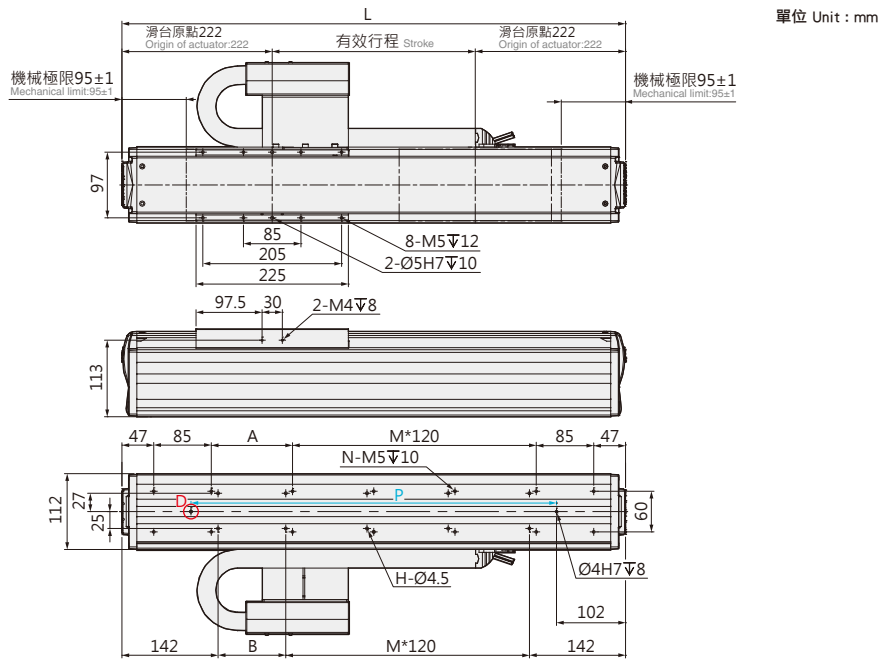
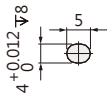

有效行程 stroke	120	180	240	300	360	420	480	540	600	660	720	780	840	900	960	1020	1080	1140	1200	1260
L	564	624	684	744	804	864	924	984	1044	1104	1164	1224	1284	1344	1404	1464	1524	1584	1644	1704
A	60	120	60	120	60	120	60	120	60	120	60	120	60	120	60	120	60	120	60	120
B	40	100	40	100	40	100	40	100	40	100	40	100	40	100	40	100	40	100	40	100
P	360	420	480	540	600	660	720	780	840	900	960	1020	1080	1140	1200	1260	1320	1380	1440	1500
M	2	2	3	3	4	4	5	5	6	6	7	7	8	8	9	9	10	10	11	11
N	12	12	14	14	16	16	18	18	20	20	22	22	24	24	26	26	28	28	30	30
H	8	8	10	10	12	12	14	14	16	16	18	18	20	20	22	22	24	24	26	26
KG	13.7	14.6	15.5	16.4	17.3	18.2	19.1	20	20.9	21.9	22.8	23.7	24.6	25.5	26.4	27.3	28.2	29.1	30	31

LMR25-06-LW-D



CAD圖面可至www.toyorobot.com下載
Please download the CAD file from TOYO's website: www.toyorobot.com

履帶截面圖
Sectional view of connecting track

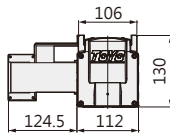
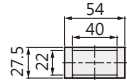

D View

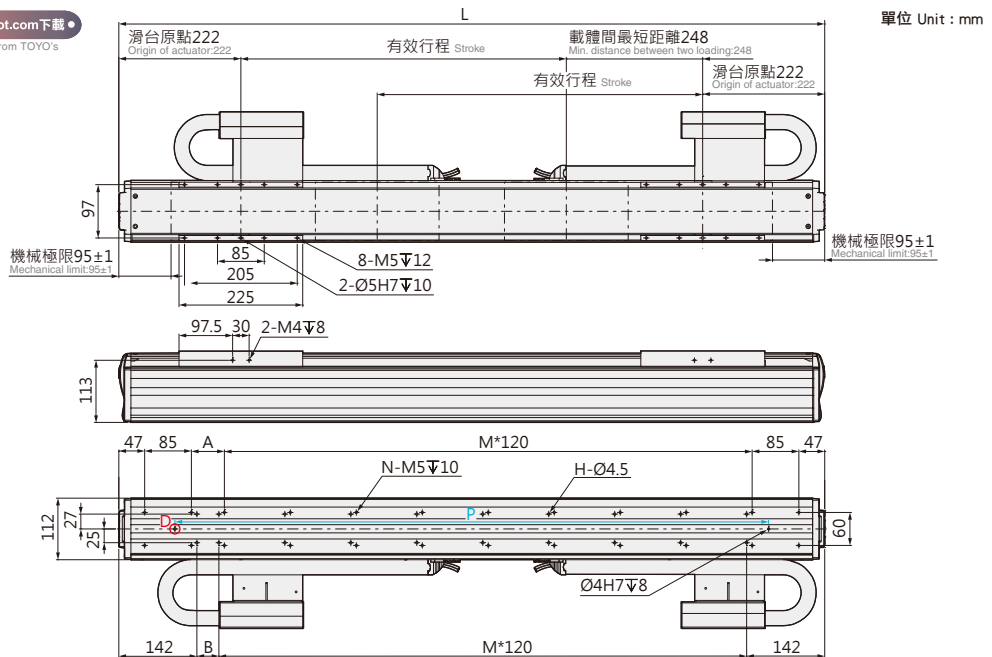
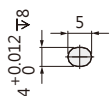

有效行程 stroke	50	110	170	230	290	350	410	470	530	590	650	710	770	830	890	950	1010
L	744	804	864	924	984	1044	1104	1164	1224	1284	1344	1404	1464	1524	1584	1644	1704
A	120	60	120	60	120	60	120	60	120	60	120	60	120	60	120	60	120
B	100	40	100	40	100	40	100	40	100	40	100	40	100	40	100	40	100
P	540	600	660	720	780	840	900	960	1020	1080	1140	1200	1260	1320	1380	1440	1500
M	3	4	4	5	5	6	6	7	7	8	8	9	9	10	10	11	11
N	14	16	16	18	18	20	20	22	22	24	24	26	26	28	28	30	30
H	10	12	12	14	14	16	16	18	18	20	20	22	22	24	24	26	26
KG	24.7	25.6	26.5	27.4	28.3	29.1	30	30.9	31.8	32.7	33.5	34.4	35.3	36.2	37.1	38	38.8